

LEGENDS

Bengt H. Fellenius
Dr.Tech., P.Eng.
DFI DaVinci
Legend Award 2019

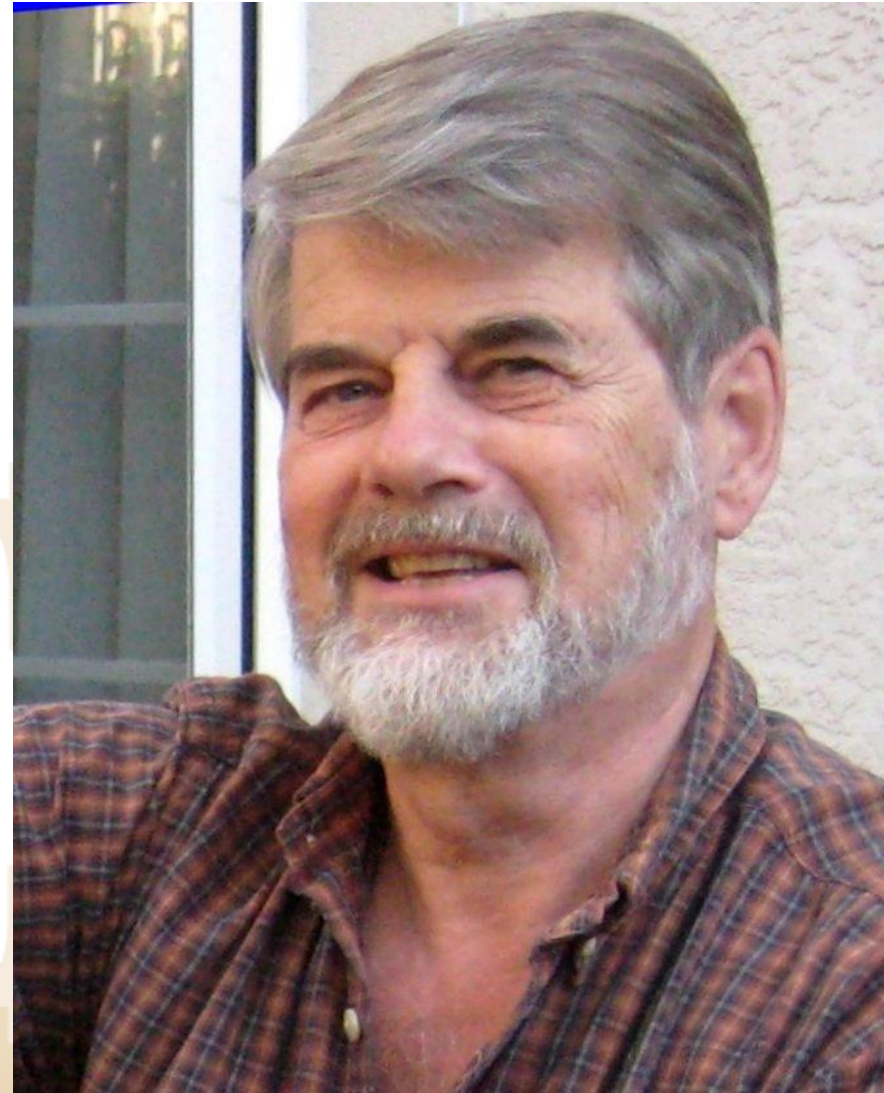

LEGENDS

Bengt was born in 1936 in Göteborg, Sweden, and grew up in Stockholm. High school was Norra Real, which also had been the school of his brother, his father, his grandfather, his cousins, and his uncles.

After army service, he tried medicine and philosophy studies, but after a few semesters, he settled for civil engineering at Royal Institute of Technology, Stockholm.



Norra Real



Royal Institute of Technology

LEGENDS



1938 with twin sister Ingrid



1954 summer student at
Soil Mechanics Ltd.,
London, UK



1955 Bacheloria

LEGENDS

Bengt's father was Bror Fellenius, geotechnical engineer and head of the Swedish Railways Geotechnical Department. Bror Fellenius was chairman of the Swedish Pile Commission during its first 25 years.

Bengt's grandfather was Wolmar Fellenius of slip-circle fame. Less known is that Wolmar Fellenius also invented the word geotechnique ("geoteknik" in Swedish) and developed bearing capacity analysis for footings.



Wolmar Fellenius
(Grandfather)

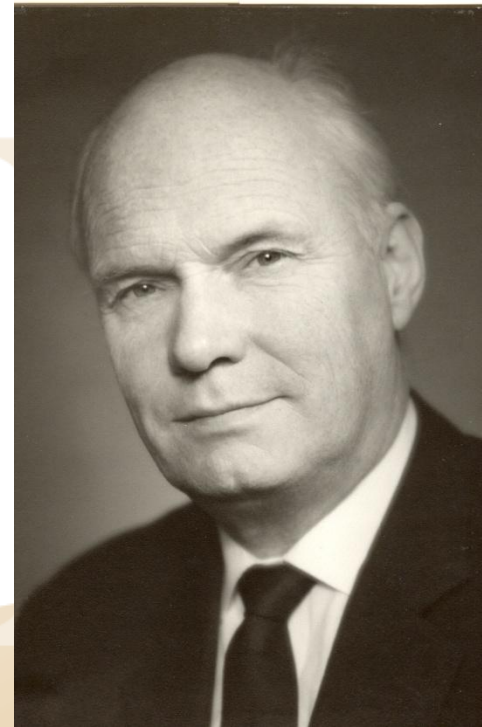
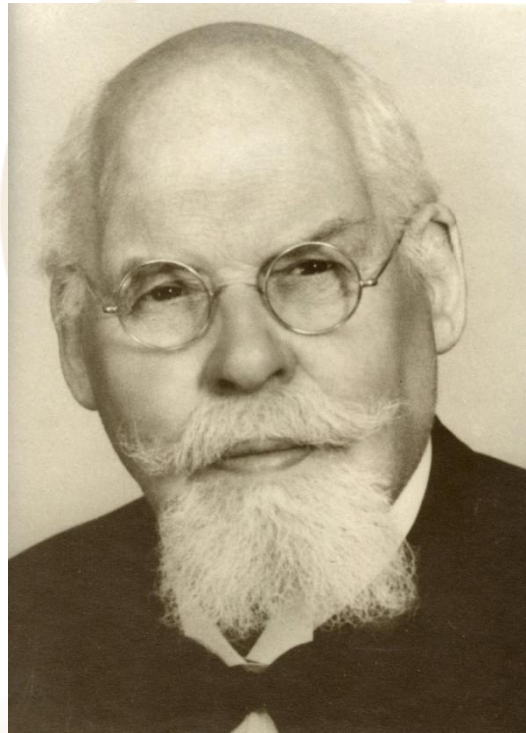

Bror Fellenius
(Father)

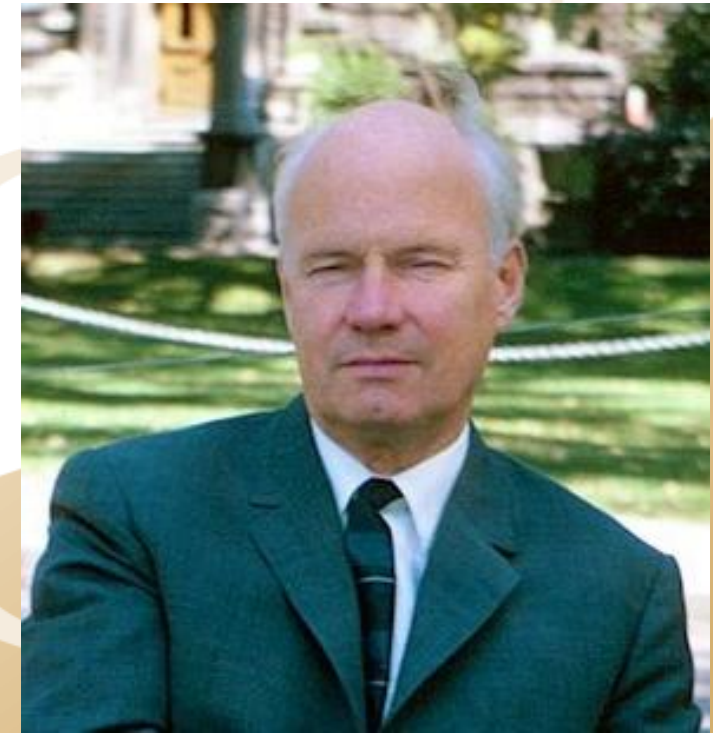

LEGENDS



Field work for a M.Sc. on
“New settlement theory for clay”,
a Dissertation Report of little
consequence.



Bäckebol tests 1968 - 1980 on development
of drag force on single piles.
A part of Bengt's Thesis on Long-term
response of piles to an applied load.



LEGENDS



Bengt married Annbrit Arkel in 1960, now almost 60 good years ago.



1970



1990



2010

LEGENDS

1971



Karl 1 year, Erik 6 years, Jan 4 years in 1967.

1997



1994 Lena, first grandchild

LEGENDS



2003 Riding Santo Domingo



1982 Riding in Cuba



1995 Skating the Rideau Canal



2017 Skating in Salt Spring, BC



2009 Skating in Bow Park, Calgary.



LEGENDS



2011 Skiing with Annbrit at Mount Washington, BC



1995 Hiking with Annbrit in Rideau Lakes, ON



LEGENDS

Bengt moved from Stockholm, Sweden, to Montreal (QC) in 1972, Ottawa (ON) in 1979, Calgary (AB) in 2002, and Sidney (BC) in 2009.

He has 60 years of engineering work in contracting and consulting engineering fields. For 20 of those years, he was also Professor of Civil Engineering at the University of Ottawa.

His practice has involved foundation design for industrial plants, water and sewage treatment facilities, bridges, highways, and marine and urban structures.

In 1977, he was the 3rd geotechnical consultant to acquire Pile Driving Analyzer

He has authored 400+ technical papers primarily on piled foundations.



1977

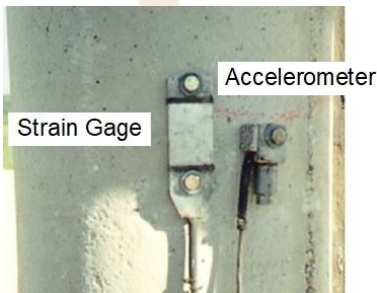

LEGENDS

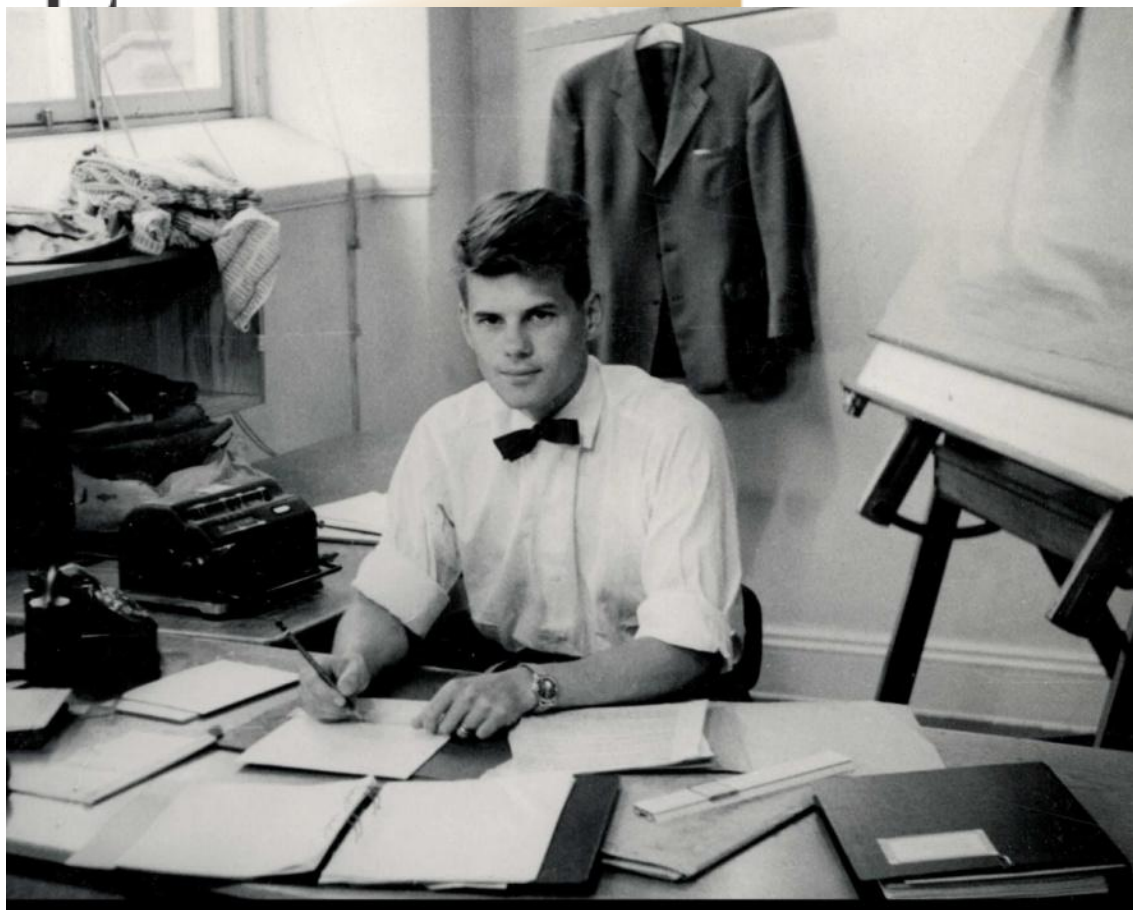

1963, Bengt at his desk at the Railways.
Note the slide rule and draught board.

On completing the M.Sc., 1962, Bengt's first job was as a very junior structural engineer with the Bridge Department of the Swedish State Railways. Within a year, however, he came down to earth and shifted to geotechnical engineering at a Orrje & Co., a consulting engineering firm. In 1965, having learnt a lot of "how to", he moved to the Swedish Geotechnical Institute to also learn something about "why so". This led to his research project in Bäckebol and a doctoral degree in 1972. That same year, he accepted an offer to move to Canada. He started with a contractor, Western Caisson, but, a year later, shifted to a consulting engineering firm, Terratech Ltee. in Montréal. In 1977, he was ready to start out on his own and was fortunate to be called in on projects across North America, in West Africa, and in South America. But, he soon found out that that international travel was not compatible with raising three teenagers and he was happy to accept an offer to join the University of Ottawa (1979), where he could pursue his interest in soil improvement techniques and analysis and design of piled foundations.

Bengt continued his consulting engineering practice and also formed a company together with Robert Edde (on Robert's graduation from UoO) pursuing PDA/CAPWAP assignments and a software company (UniSoft Inc.) with Pierre Goudreault, also a former student. Pierre is still running UniSoft and the company has customers (Users) in more than 50 countries.



LEGENDS

Bengt's main professional interest lies in basing design and decisions on proper analysis of results of full-scale field tests. He has had the advantage of participating in a large number of projects learning from highly knowledgeable and experienced engineers engaged in the projects. A few examples:

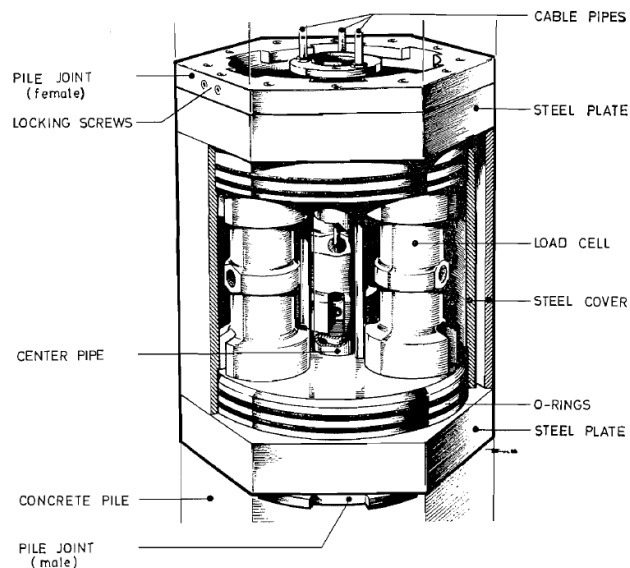

1967 Pile force gage.
Measuring axial force
independently of the pile
E-modulus and with true
zero reference.



1968 St. Charles River, Quebec



1970 Glasgow, Scotland

LEGENDS

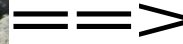

A stone bed (old shore line) some 5 m below ground and its pile-toe effect



Too thick cover on hard driven piles



H-pile driven to sloping bedrock



Too hard driving

The challenge of resolving why things go wrong

LEGENDS



1995 Port of Los Angeles, California



2000 HWY416, Ontario,
wickdrain full-scale project



1974 Timmins, Ontario, resolving
cause of broken piles



1971 Svärta Slide,
Rissa, Sweden,
3.5 m artesian head



LEGENDS

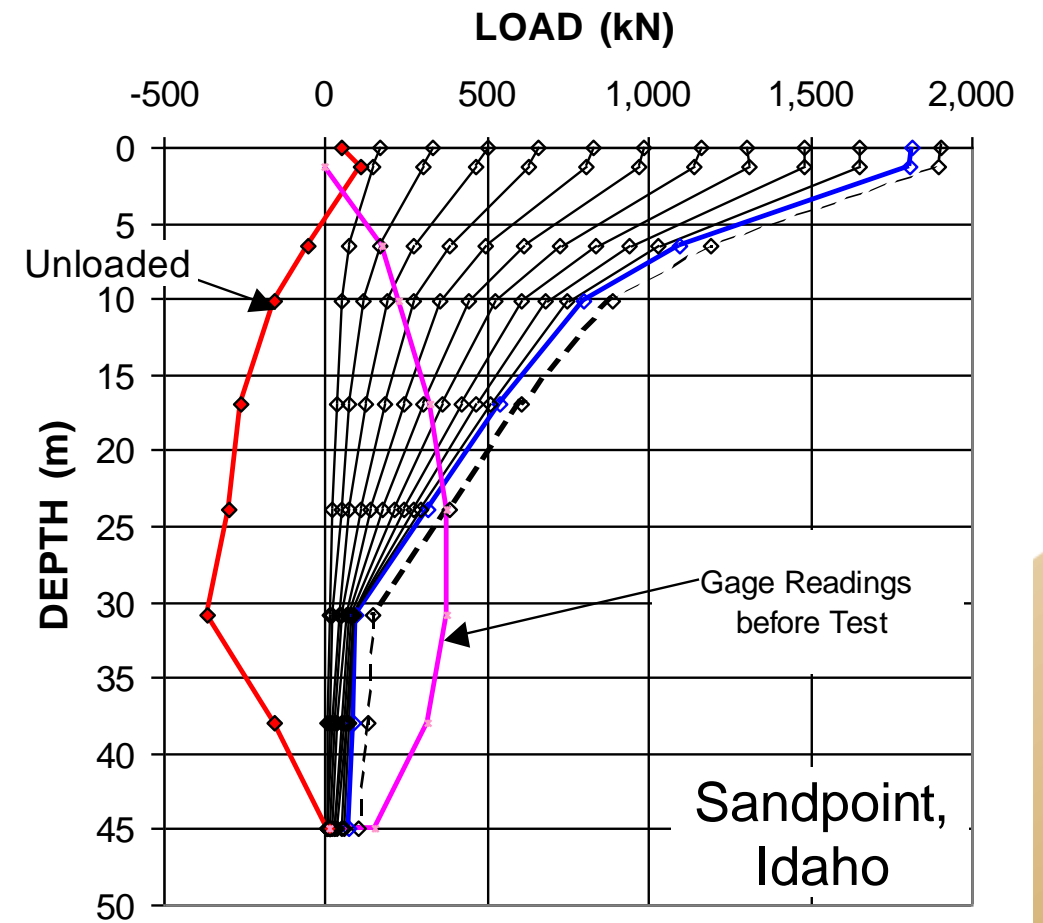
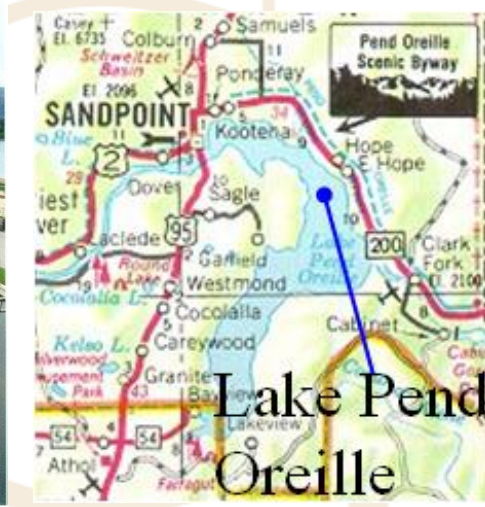
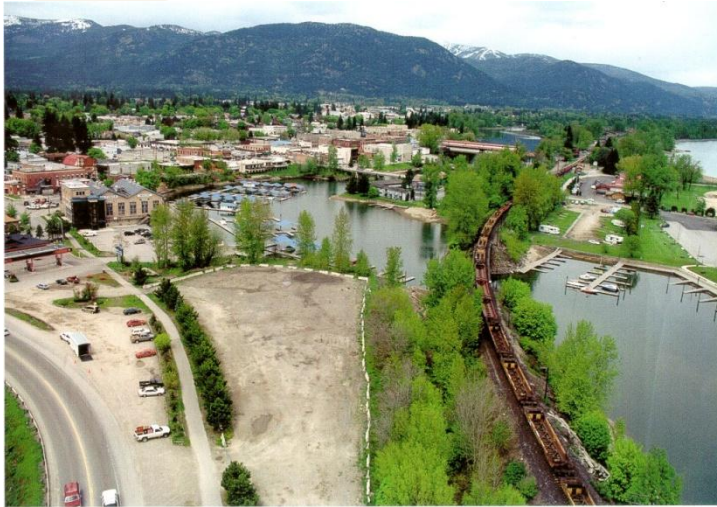

2000 Sandpoint
Bridge over 200 m soft clay and example of residual force

LEGENDS

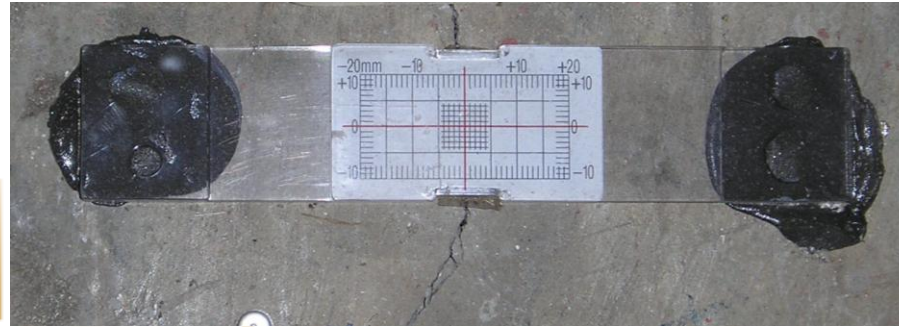

The 130 m tall, 2,560 m² footprint, 30-storey Church Street Tower was built in 2000 (not called “Millennium Tower”) on 72 bored piles , 0.9 m to 1.5 m diameter.

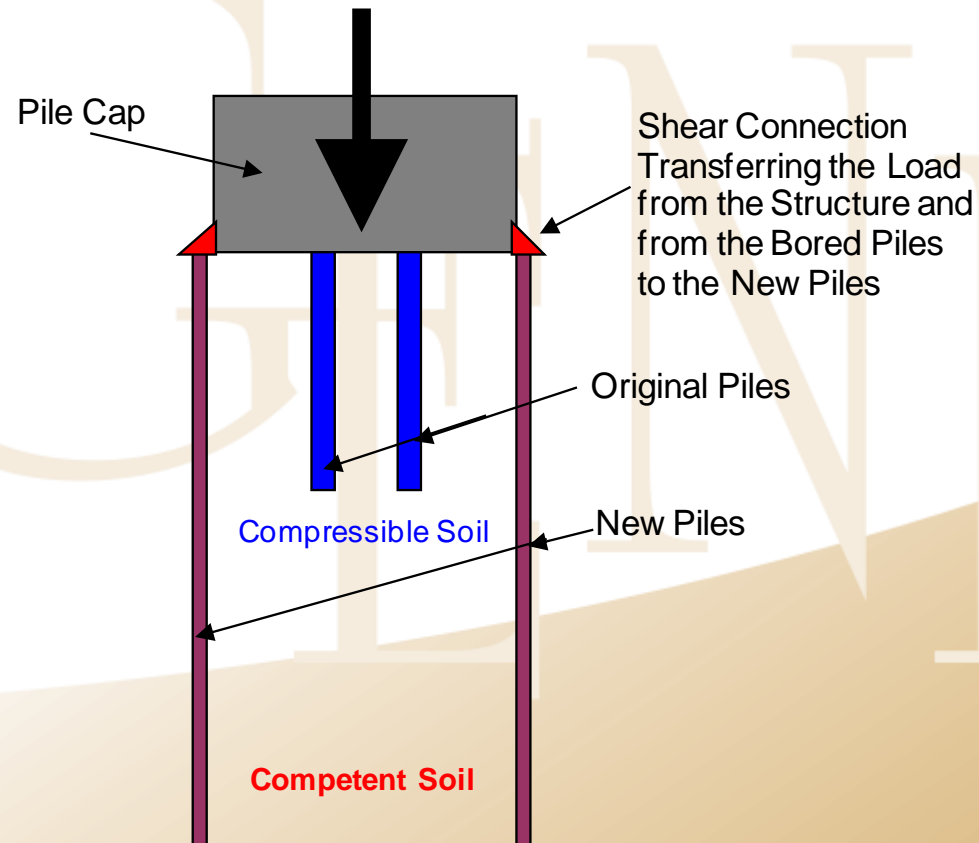

Within the first year of completion, the structure had settled 100 to 300 mm and tilted 200 mm. Remediation included pairs of heavy wall pipes (500 mm) socketed into bedrock with a 305HP198 grouted inside, replacing the original piles. The new piles were jacked up against the foundation. A key issue was the shear connection to the existing pile caps.

2003 Church Street Tower, Singapore

LEGENDS



2004 Testing for the possibility to add storeys to bank building in San Juan, PR, included going in under the basement floor to find an existing pile to test.



2006 Two cities being built over soft, settling ground in Pusan, Korea, included studies of ground settlement, downdrag, and applying unified design principles as opposed to conventional bearing capacity design.



LEGENDS

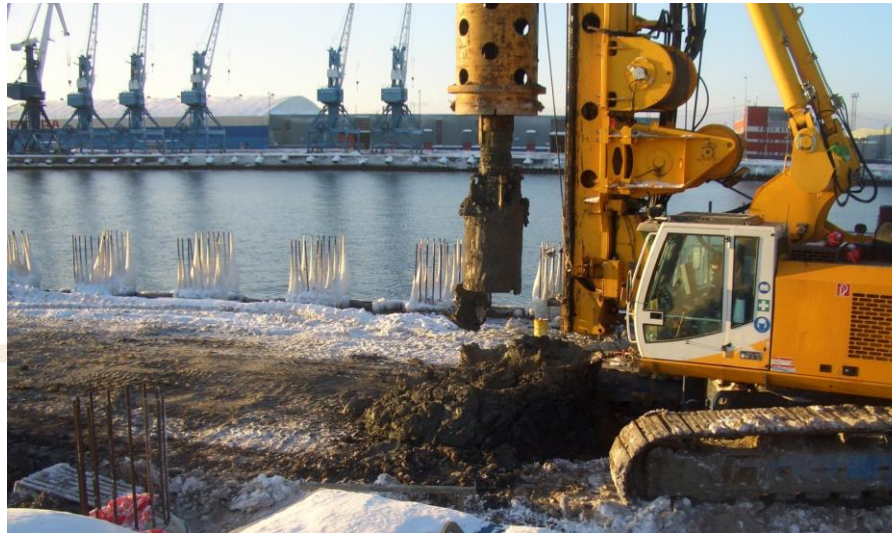

2006 Harbor in Muuga, Estonia.
Settlement of 45 m long pipe piles



2007 Orchard Center,
Singapore. Head-down and
bidirectional test on same pile

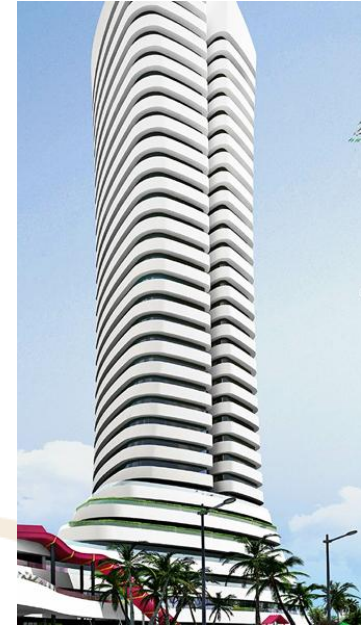

2008 Amwaj Tower, Dubai.
Evaluation of full-scale
multi-level bidirectional
loading tests.



2008 Golden Ears Bridge, Vancouver, BC.
“Pile pad” on floating piles in marine clay.

LEGENDS



2011 Cai Mep Container Port, Vietnam.
Remediation of excessive settlement
after a failed wick drain treatment.

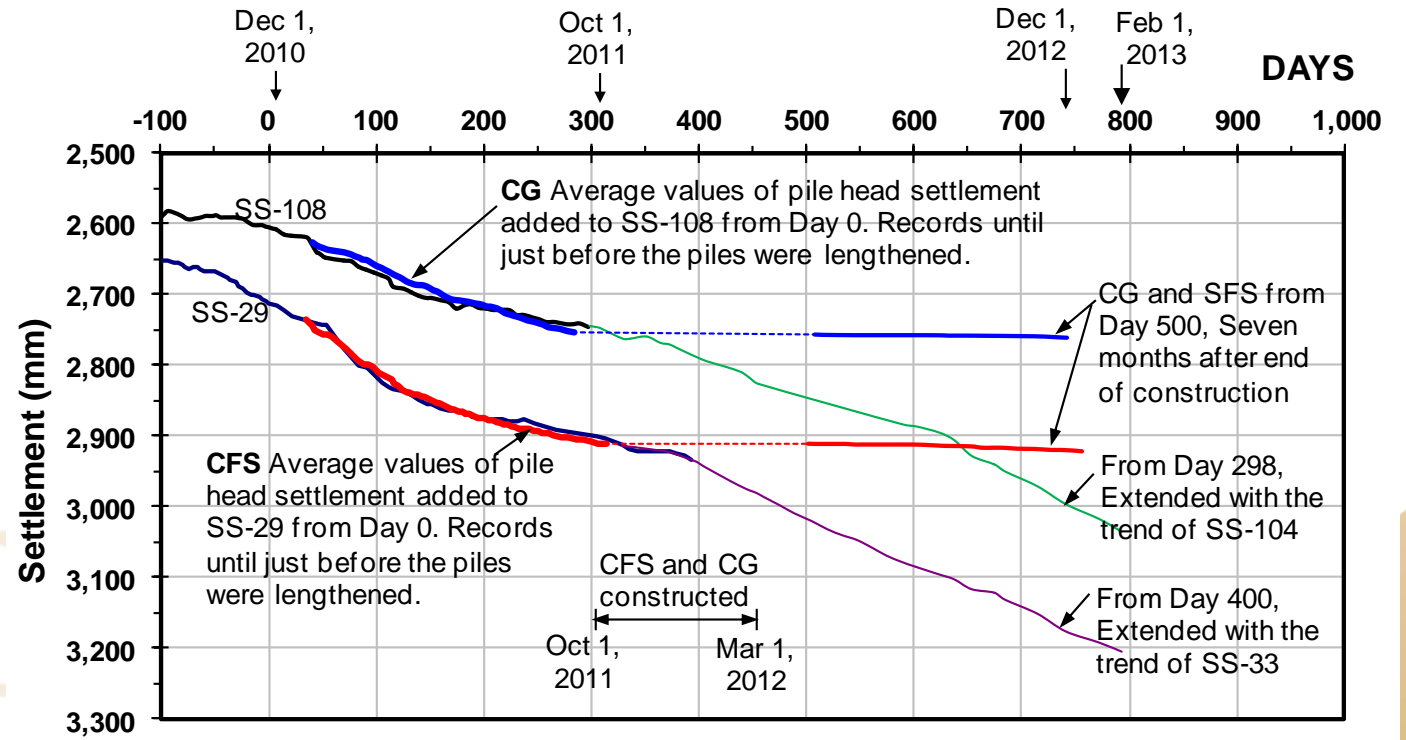

LEGENDS

2013 Tappan Zee Hudson River Crossing, New York.



2013 w. Dan Brown and Mike Holloway

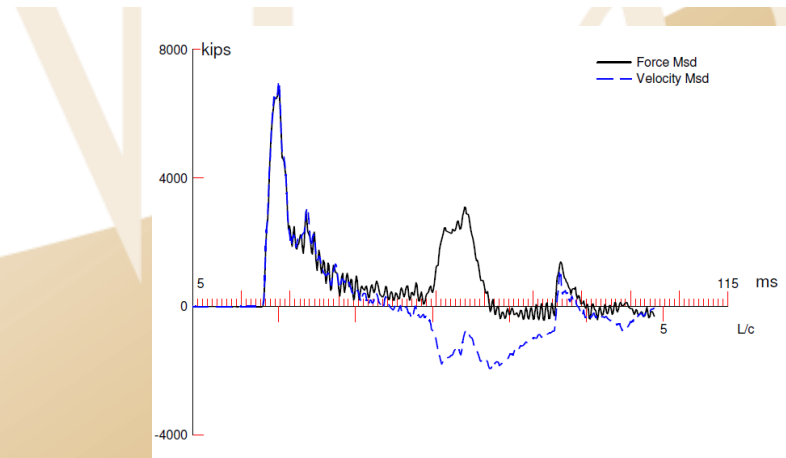
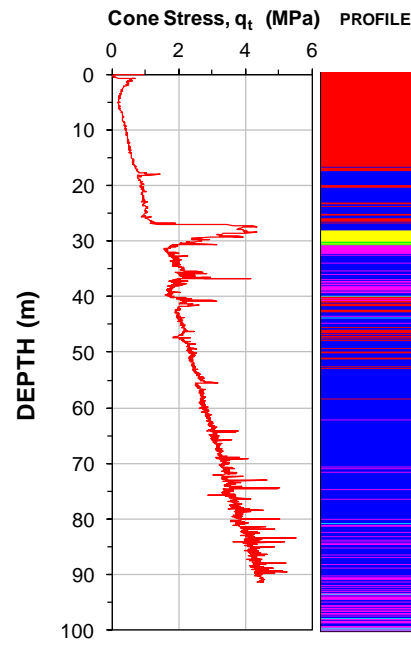
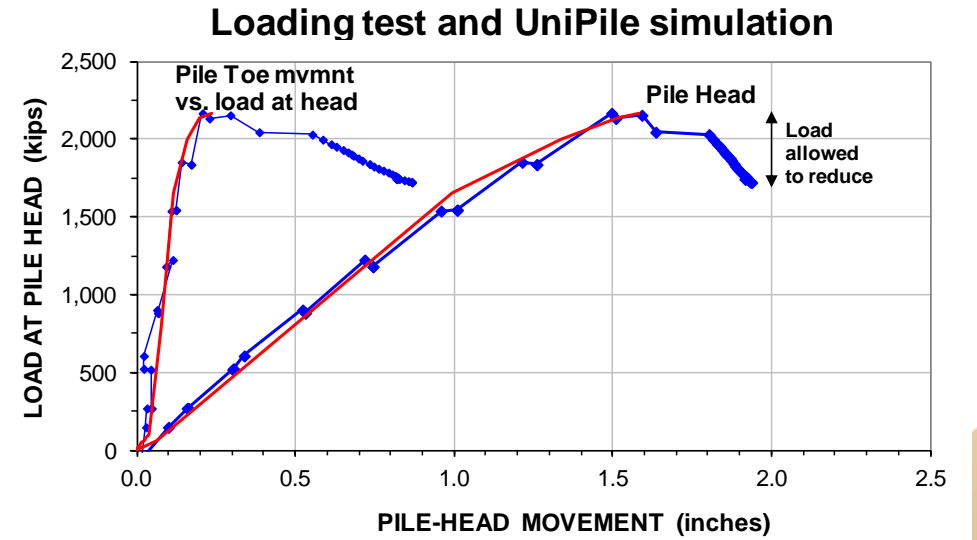

LEGENDS

In 1984, Bengt published “The unified design method” that builds on the interaction loop between pile toe movement and downdrag to show the long-term settlement of a piled foundation. The method is now included in many codes and standards.

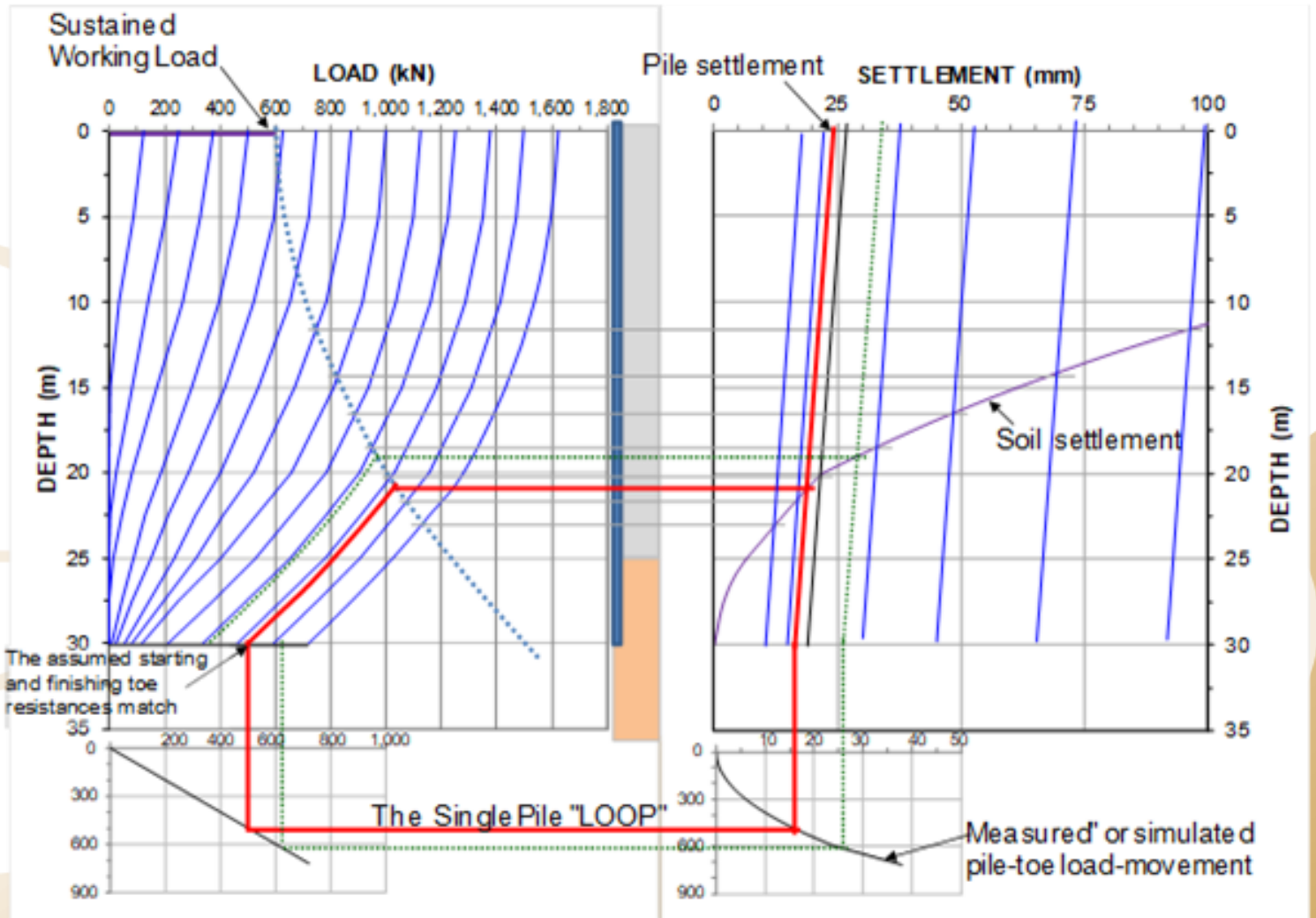

LEGENDS



2013 w. Pierre Goudreault

Bengt's career encompasses the progression from the slide rule to the computer—getting an Apple II with a disk drive in about 1982. In early 1990, he collaborated with Pierre Goudreault to code his methods into the desktop computer, which resulted in the two incorporating UniSoft Inc. in 1994 for promotion of UniPile and UniSettle software for analysis and design of piled foundations, design and analysis of head-down and bidirectional loading tests, and settlement analysis of embankments including wickdrain acceleration of settlement.

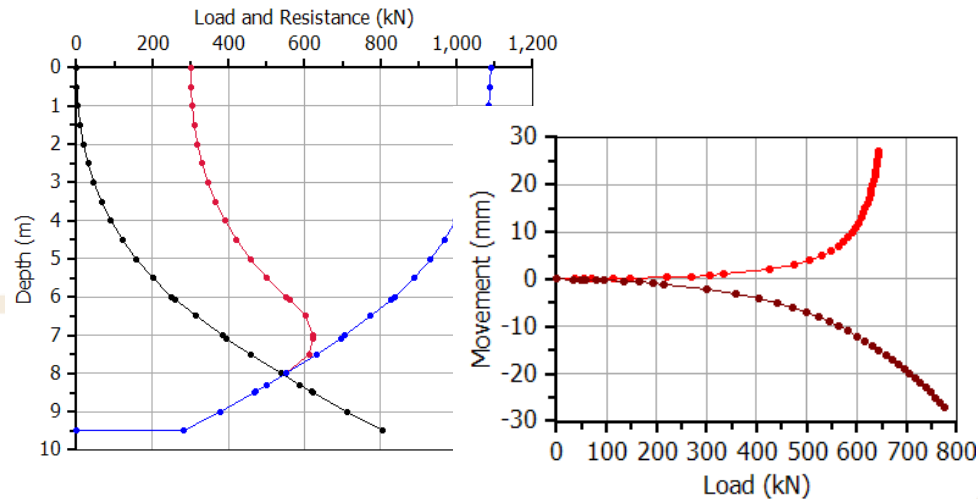

● $Q_d + \Sigma Q_n$
 ● ΣR_s
 ● $R_u - \Sigma R_s$
 ● Head Movement
 ● Toe Movement

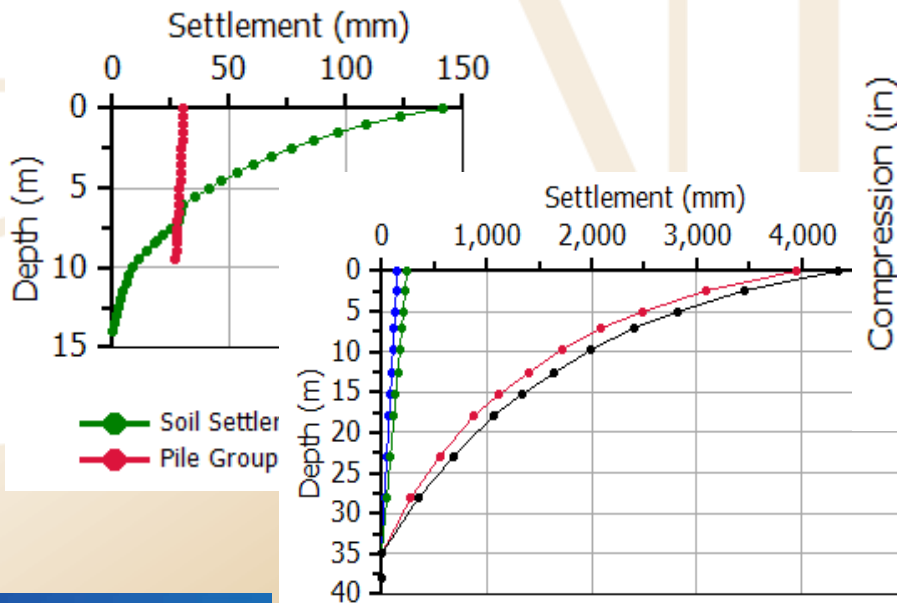

● Soil Settler
 ● Pile Group

● Immediate
 ● Consolidation
 ● Secondary
 ● Total

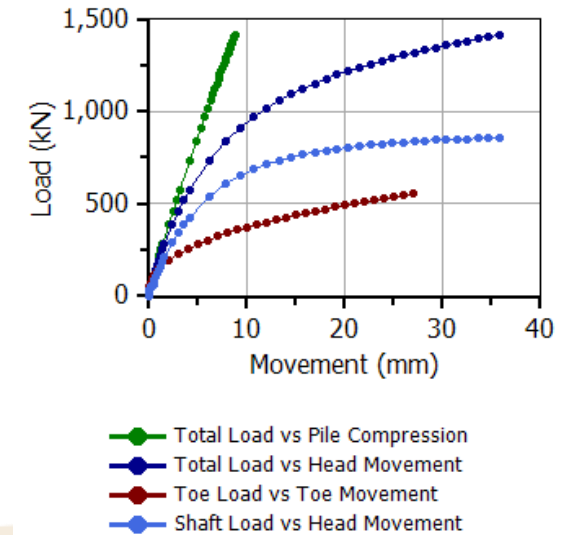

● Total Load vs Pile Compression
 ● Total Load vs Head Movement
 ● Toe Load vs Toe Movement
 ● Shaft Load vs Head Movement

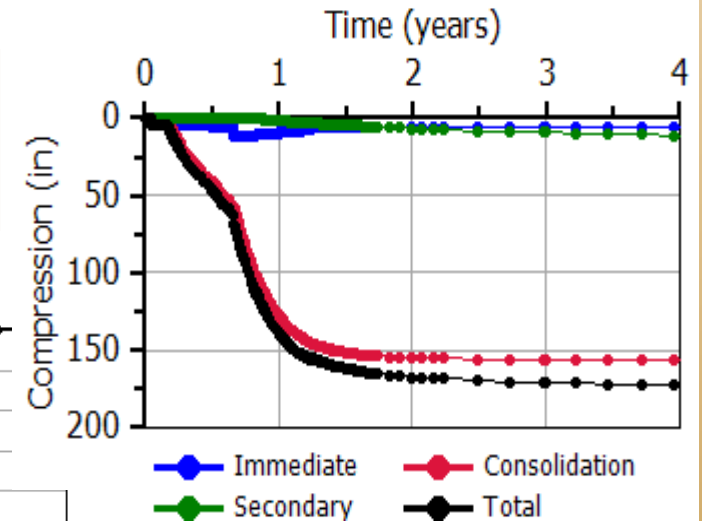

● Immediate
 ● Consolidation
 ● Secondary
 ● Total



LEGENDS

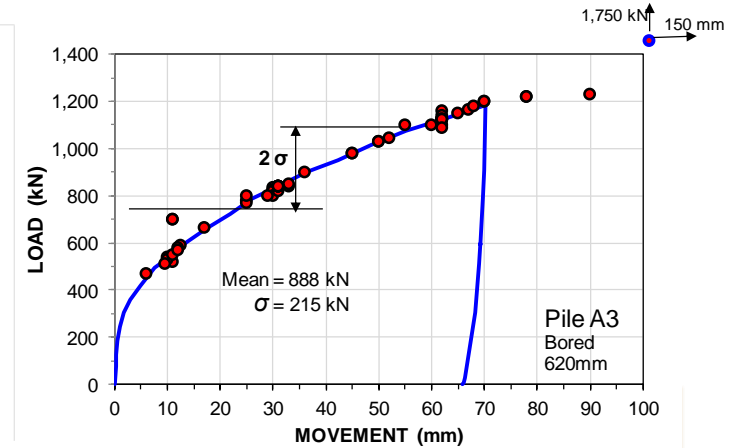
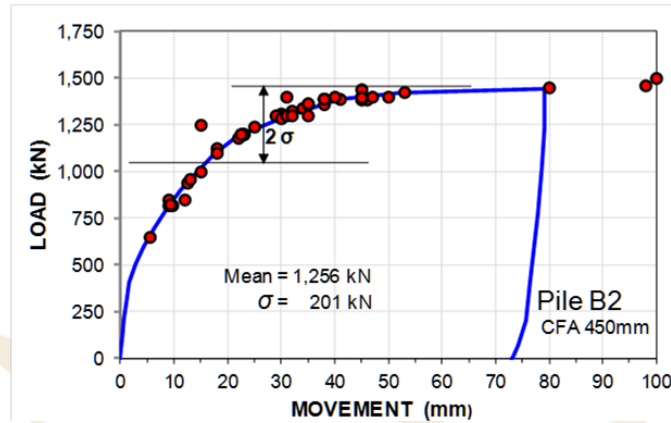

2017 Bolivia B.E.S.T. Assessments of “capacity” by 94 participants

Bengt has arranged several prediction events, inviting specialists to assign a “capacity” to the results of a static loading test. The results have shown that the assessed “capacity values” are almost as many as the participants in the event.

Bengt concludes that the profession has no common definition (maybe not even an understanding) of “capacity” and that society will much improve safety and save costs if changing to designing for deformations and settlement of piled foundations—which would greatly help to avoid new “millennium” events.

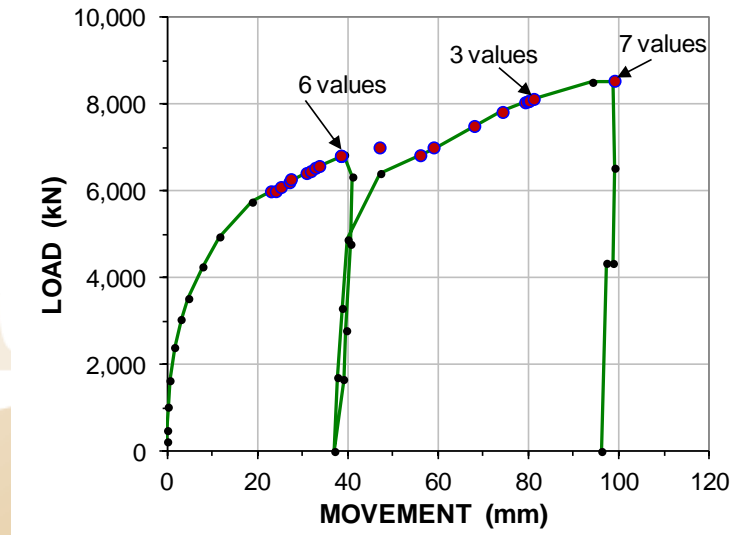

2015 Araquari Test
Assessment by 29 participants



LEGENDS



Recently, Bengt advanced the unified design method to encompass wide pile groups, showing how to consider the difference in response for perimeter and interior piles as a function of the rigidity of the foundation raft.

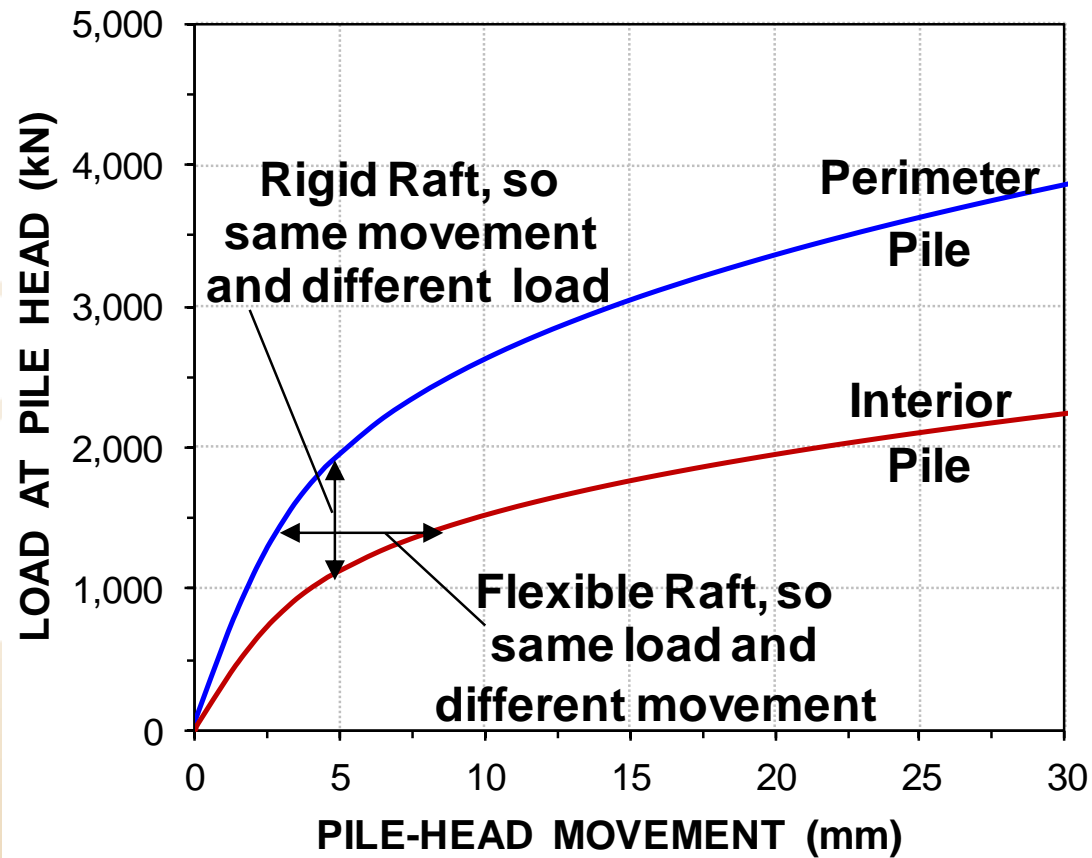

LEGENDS

Bengt believes strongly that engineers, having learnt something, have an obligation to pass this on to their peers. He has lived up to this by publishing numerous papers and presenting seminar and lectures around the world, as well as participating in professional societies, such as the DFI, ASCE, ASTM. He has served on national codes and standards committees, and as an executive on local geotechnical chapters. He is proud of having been a member of the steering committee that initiated the DFI.





Six of the 13 Steering Committee members: Stiles Sevens, Bob Compton, William Kruse, Joseph DeSalvo, Bengt Fellenius, and Jack Dougherty meeting in New Jersey in 1974



LEGENDS

Bengt makes his publications available for free downloading from his website, www.fellenius.net, including his textbook “The Red Book”. He has the great satisfaction to see that the downloading count shows the Red Book, alone, to be downloaded about 200,000 times/year. He states that “*I might not convince my peers that well, but I believe I will succeed with those of the future*”. A side benefit that he appreciates is that many—students, as well as practitioners—email him with queries and, sometimes, discuss their case studies with him.

Bengt H. Fellenius, Dr.Tech., P.Eng.





1973 2005

2475 Rothesay Avenue
Sidney, BC
Canada V8L 2B9

Telephone:
(778) 426-0775

Email: Bengt (at) Fellenius (dot) net

I apologize for not having replied to those who have tried to connect to me via Linked-In, Research-Gate, and other such sites. However, I do not participate in these social networks (not even Facebook). My name is still on these lists only because these sites do not allow people to opt out. I do reply to e-messages though.



LEGENDS

Bengt holds that participating and sharing information and making personal contacts in conferences is invaluable for professional development. He also very much appreciates the opportunity to meet old friends and make new friends and contacts.



1991 DFI Stresa
The Comptons' and Fellenius'



1993 w. Mohamad Hussein
and Mike Holloway

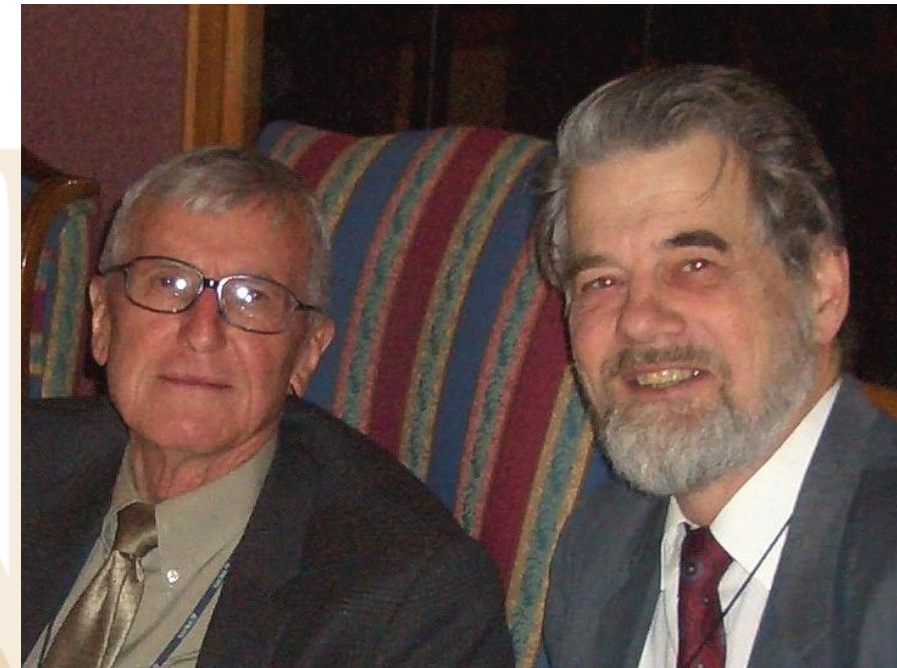

2010 w. George Goble



LEGENDS



1972 and 2013 w. Bob Holtz

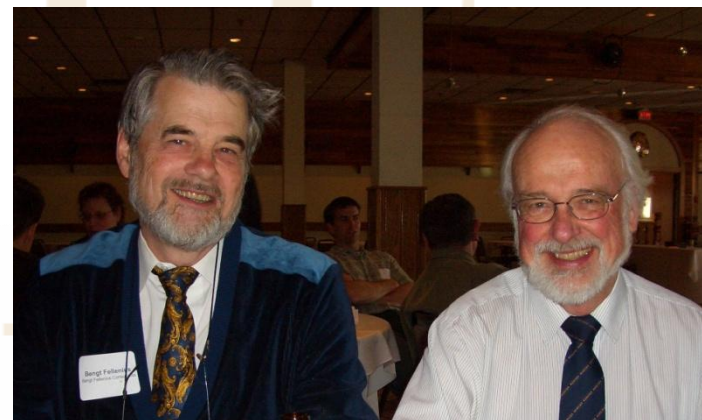

2013 w. Harry Tan



2010 w. Harry Poulos



2013 w. Rainer Massarsch and
Suzanne Lacasse



2010 w. Dan Brown



LEGENDS



2013 w. Joram Amir

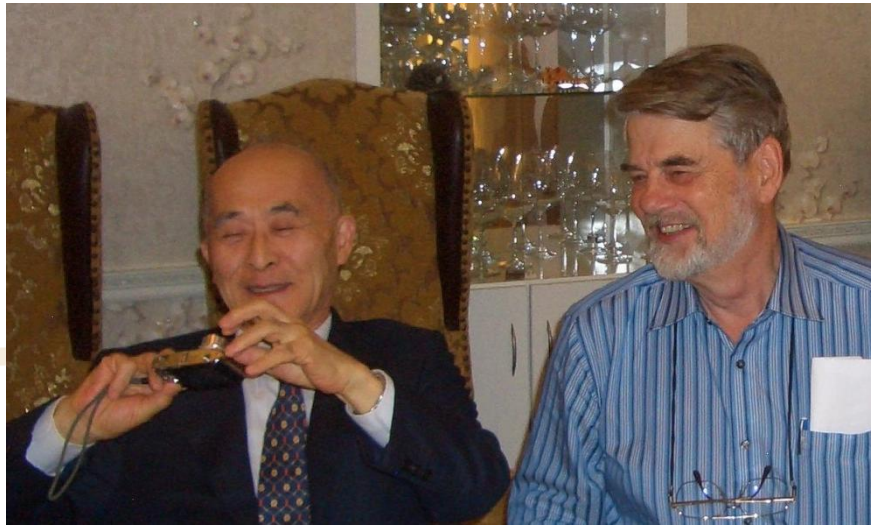

2011 w. Kenji Ishihara



2011 w. Nguyen Hai Minh

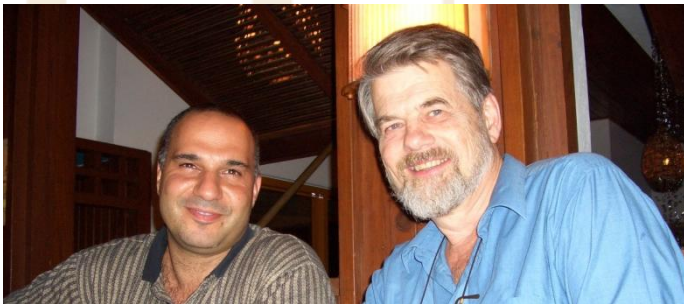

2004 w. Hicham (Sam) Salem



2013 w. Brian Simpson and
Nguyen Tien Truong

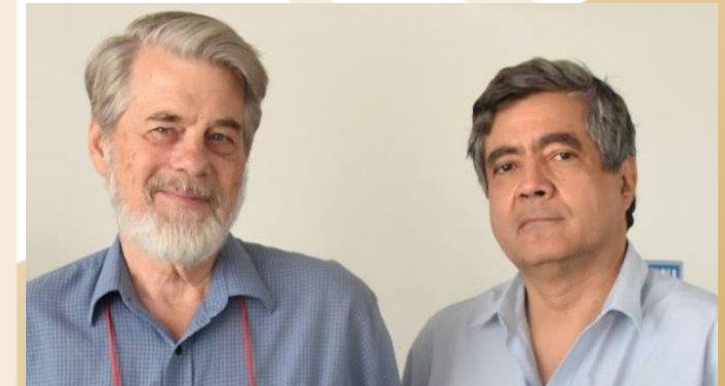

2011 w. Mario Terceros

LEGENDS



2016 dancing in Hanoi, Vietnam



2013 w. Chung Sung Gyo



2009 w. Nelson Aoki and Jamie Santos

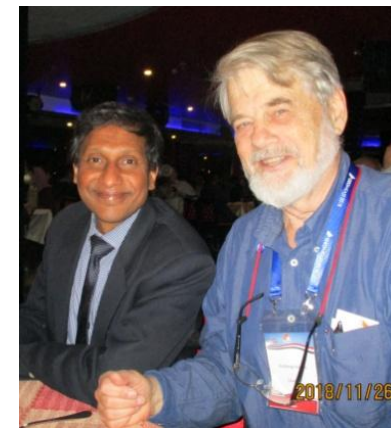

2018 w. Buddhima Indraratna

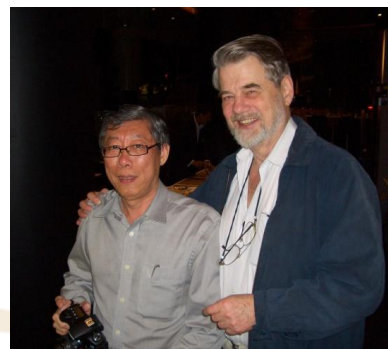

2011 w. Soh Seng Siong



2014 w. Jim Mitchell



2017 w. Abolfazl Eslami



2018 w. Robert Edde



2011 w. Onanir Inanir



2018 w. Izzat Idriss



2017 w. Mauricio Ochoa



LEGENDS

2017 Bolivian Experimental Site for Testing Piles, B.E.S.T.



Planning Committee: Rainer Massarsch, Mario Terceros,
Alessandro Mandolino, Bengt Fellenius



Ready for one of 25 loading tests.



Installation of a pile with
Expander Base (EB)



LEGENDS

Honors and awards – A Selection

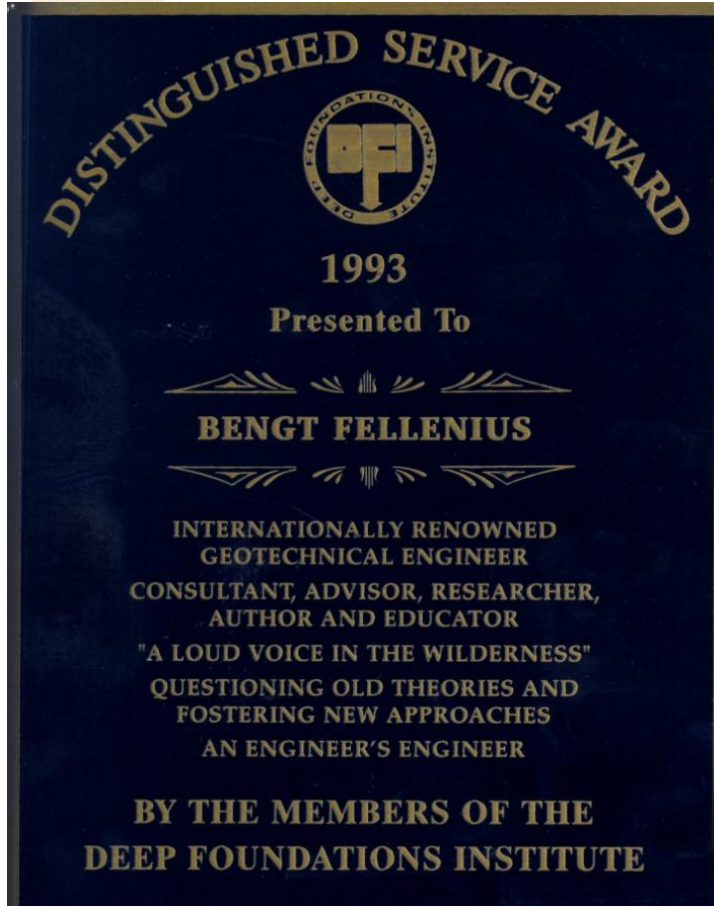

- 2018 17th Arthur Casagrande Memorial Lecturer, Boston Society of Civil Engineering, ASCE, Boston.
- 2017 Inaugural E.A.L. Smith Lecturer at the IFCEE, ASCE, GI, and PDCA Conference, Orlando.
- 2016 6th Dr. Anwar Wissa Lecturer, ASCE, Tampa.
- 2016 Inaugural Sven Hansbo Lecturer at the Vietnamese Geotechnical Society, 3rd Geotec Hanoi Conference ,Hanoi.
- 2016 The American Society of Civil Engineers, the Geolnstitute, ASCE Outstanding Reviewer Award.
- 2014 John Mitchell Lecturer, Deep Foundation Institute, at the DFI-EFFC Int. Conf., Stockholm.
- 2015 Inaugural K. Rainer Massarsch Lecturer, at Segundo Congreso Internacional de Fundaciones Profundas de Bolivia, Santa Cruz.
- 2012 Sower's Lecturer, ASCE Georgia Section, at the 15th Annual George F. Sowers Symposium, Atlanta.
- 2012 Swedish Geotechnical Society, Awarded honorary membership.
- 2010 The American Society of Civil Engineers, the Geolnstitute, Geotechnical Special Publication Honoring Bengt H. Fellenius "Role of Full-Scale Testing in Foundation Design".
- 2019 The Deep Foundations Institute, Osterberg Lecturer at the 2nd Annual Osterberg Memorial Lecture and Dinner, Boston, MA.
- 2002 The Engineering Institute of Canada, Distinction of Fellow in "Recognition of Excellence In Engineering and for Services to the Profession and to Society".
- 2001 Deep Foundation Institute, Hal Hunt Lecturer.
- 1997 Canadian Geotechnical Society, the G. Geoffrey Meyerhof Award "for Outstanding and Significant Contributions to the Art and Science of Foundation Engineering".

